

TOP VIEW

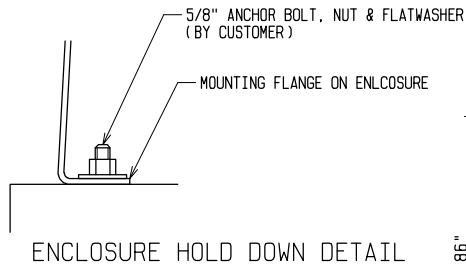

ENCLOSURE HOLD DOWN DETAIL

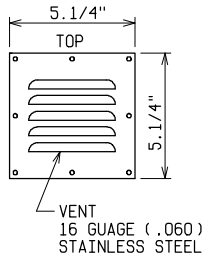

LOUVER DETAIL

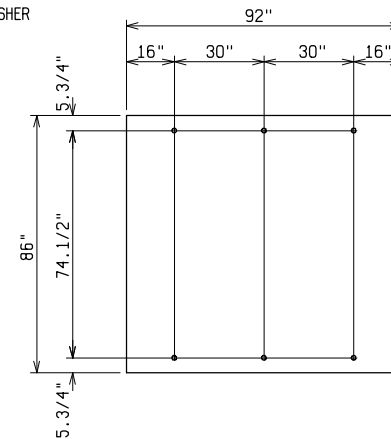
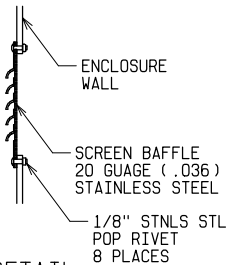

PAD & ANCHOR BOLT DETAIL

ANCHOR BOLTS TO BE 5/8" DIA. & TO EXTEND 1-1/2" MINIMUM ABOVE PAD. PROVIDE CABLE ENTRY AS REQ'D.

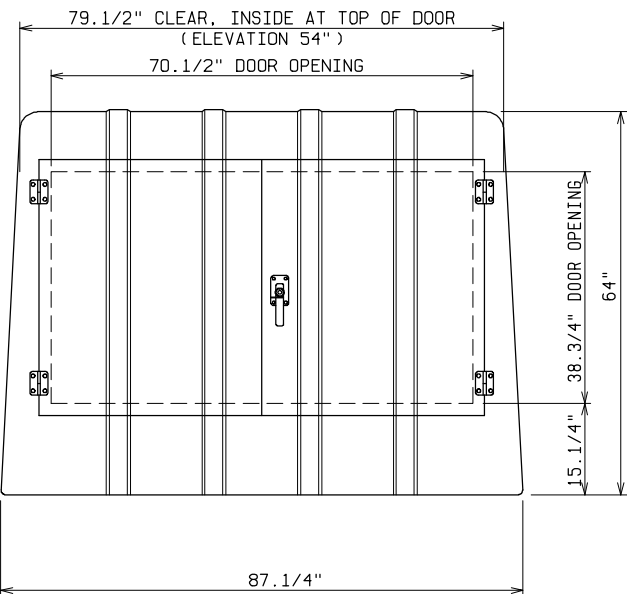

FRONT VIEW

VENTILATING LOUVER
TWO LOW END SHOWN
TWO HIGH END OPP.
SEE LOUVER DETAIL

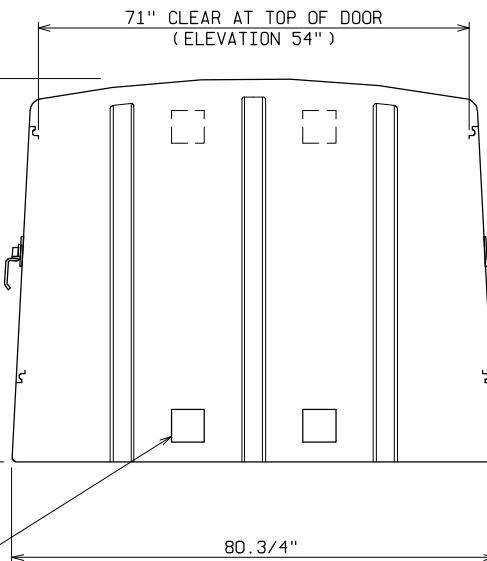

END VIEW

ORDERING INFORMATION:

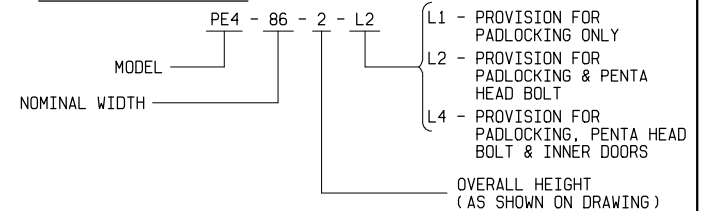

NOTE:

- MATERIAL:
 - FIBERGLASS LAMINATE 3/16" NOMINAL THICKNESS
 - EXTERIOR UV STABILIZED GELCOAT - 14 MIL NOMINAL THICKNESS
 - FIRE RETARDANT - DOES NOT SUPPORT COMBUSTION
 - STAINLESS STEEL HARDWARE
- STANDARDS:
 - CONFORMS TO ANSI C57.12.28, PADMOUNT EQUIPMENT ENCLOSURE INTEGRITY STANDARD
 - CERTIFIED TEST DATA OF ASTM STRUCTURAL STANDARDS AVAILABLE UPON REQUEST

ENCLOSURE DETAILS

PE4-86-2



POWER DESIGN INC.

ODELL, OREGON

DRAWN:
BB

PAGE

DATE
2-26-93

DRAWING NO.
1033 -R2

FILE REF.